

SPU 50 Variante Blocktype

Montageanleitung / Notice de montage / Assembly instruction

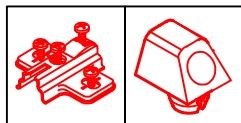
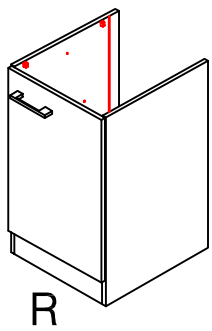
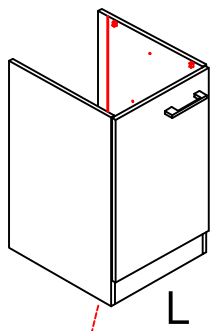

2x

4x

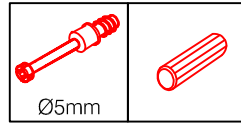

Ø5mm

4x

14x



4x

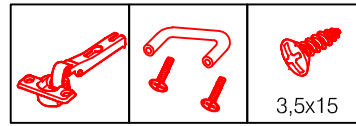
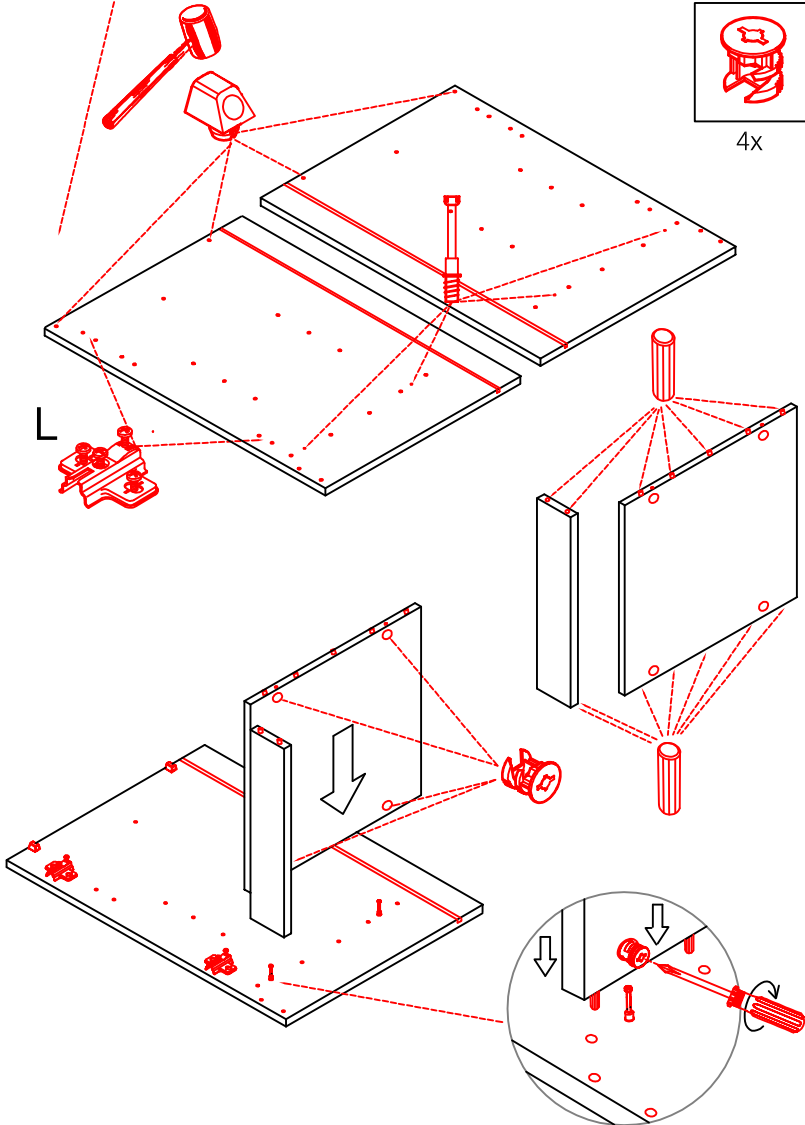

2x

1x

3,5x15

3,5x15

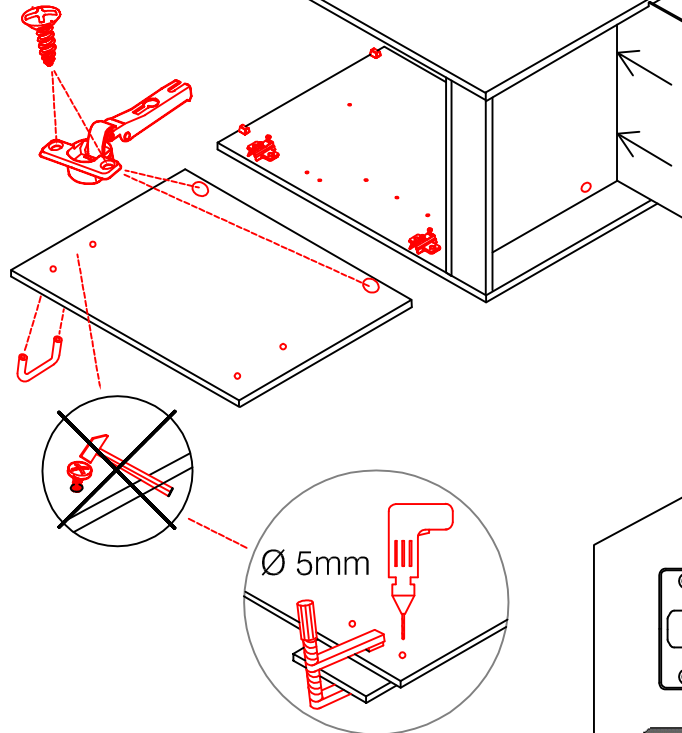

Ø 5mm

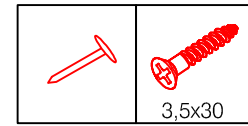

5x

3,5x30

