

# Montageanleitung Mounting instructions

## Schiebestützen / Sliding supports



Competence in Trailers

de / en

• Alle Abbildungen sind Musterabbildungen / All illustrations are representative.

# 231.00121

► Inhalt prüfen / Check content:

1. Schiebestütze / Sliding support
2. Halterung
3. Klemmschelle aufgeschraubt / Clamp screwed on
4. Selbstsichernde Mutter / Lock nut, M10
5. Scheibe / Washer, A10,5
6. 6kt.-Schraube / Hexagonal head screw, M10x25

Einsatz bei / can be used for: **STEELY**

Gebote / Bid:

Gefahren / Dangers:



x2  
x2  
x2  
x8  
x8  
x8

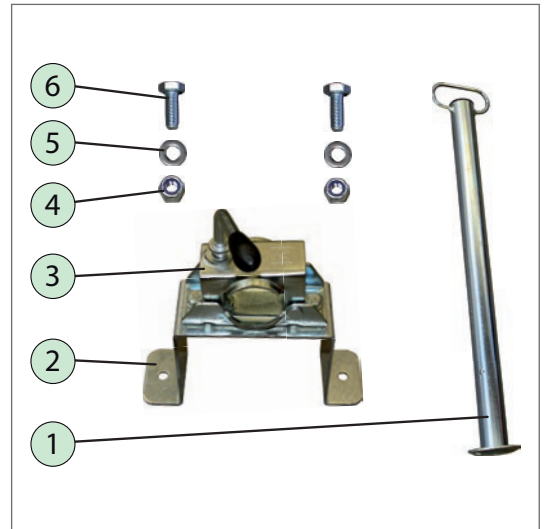

Montage - Schwierigkeitsgrad:  
mounting - degree of difficulty:

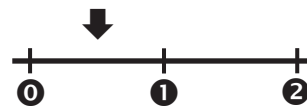

- 0 ganz leicht / easy
- 1 mittelschwer / moderate
- 2 schwer / difficult

Sie brauchen / you need:



Anwendungsbeispiel / Example of application:





# STEELY

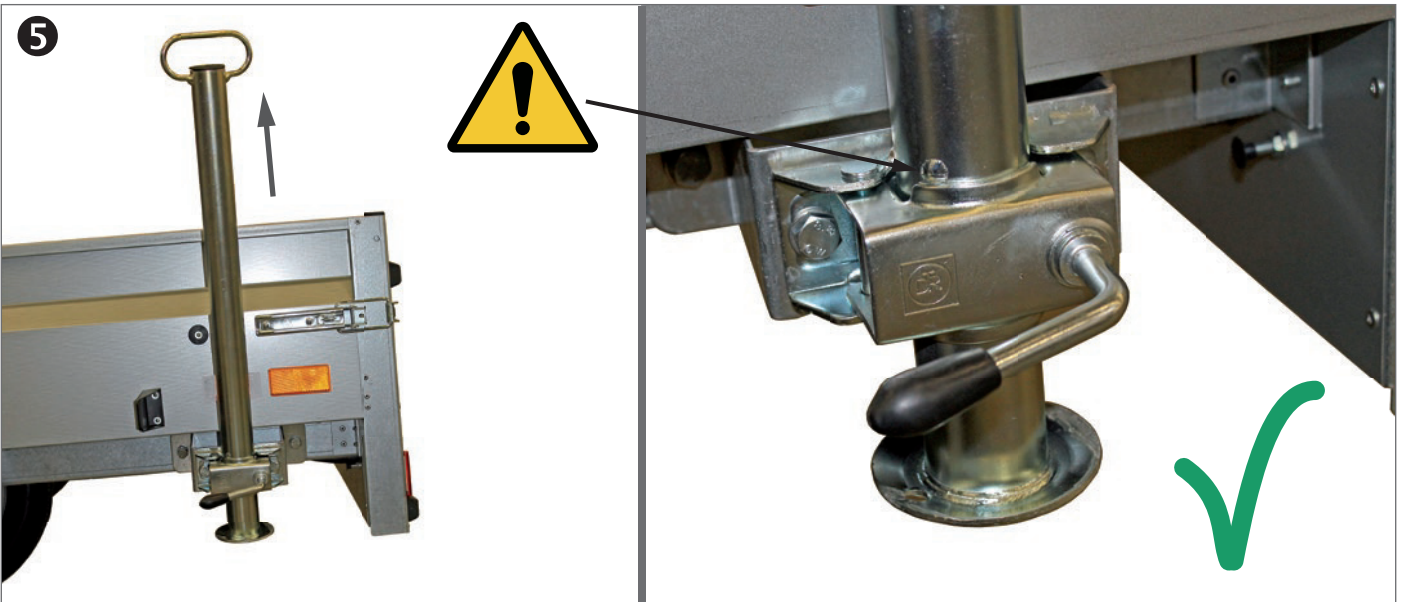
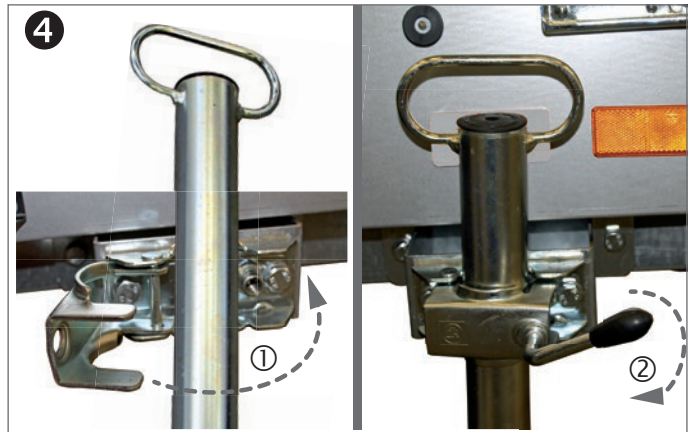
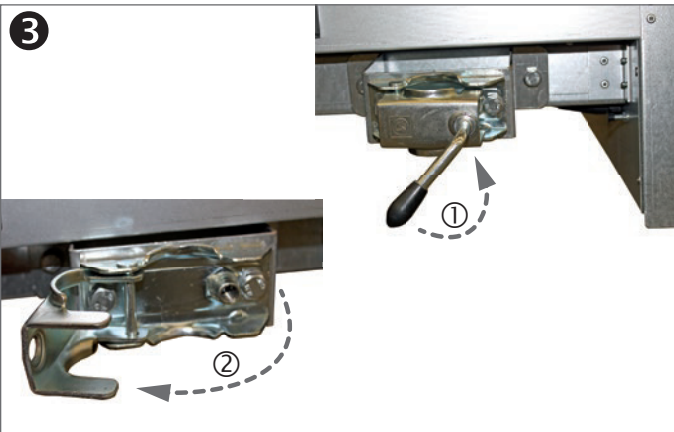
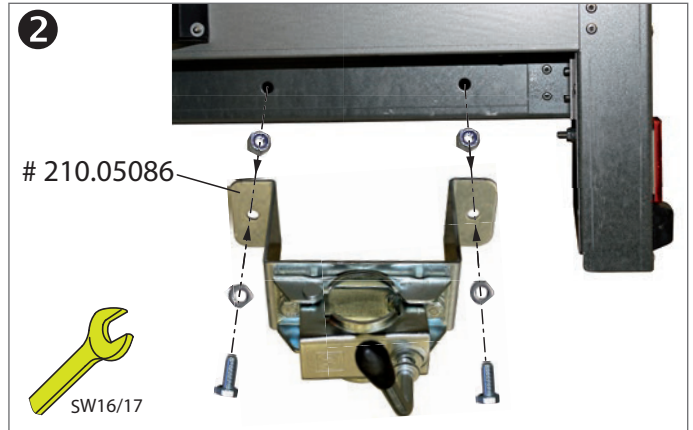
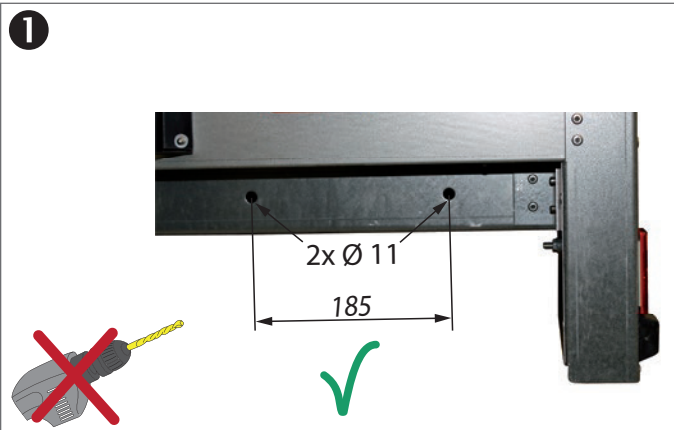

Bedienung / Wartung des Stützrades - siehe Betriebsanleitung PkW-Programm Teil 1 - Allgemein.  
Operation / maintenance of the jockey wheel - see operating instructions including car program Part 1 - General.



Für die fachgerechte Montage ist der Kunde verantwortlich. Für eventuelle Sach- oder Personenschäden die durch unsachgemäße Montage entstehen, übernimmt die Fa. Humbaur GmbH keine Haftung. *The customer is responsible for proper mounting. The company Humbaur GmbH assumes no liability in case of any property damage or personal injury caused by improper mounting.*