

















MONTAGEANLEITUNG

-  MONTAGEANLEITUNG
-  ASSEMBLY INSTRUCTION
-  DE INSTRUCTIE VAN DE ASSEMBLAGE
-  ISTRUZIONE DELL'ASSEMBLEA
-  INSTRUCCIÓN DE ASAMBLEA
-  INSTRUCTION DE MONTAGE
-  NÁVOD K MONTÁŽI
-  MONTERINGSANVISNING

-  MONTAJ TALIMATI
-  ASENNUSOHJE
-  BRUGSANVISNING
-  BRUKSANVISNING
-  UPUTE ZA MONTAŽU
-  NAVODILA ZA MONTAŽO
-  SZERELÉSI ÚTMUTATÓ
-  INSTRUCIUNI DE MONTAJ



Modell-Nr.

12040

ART.-NR. FRONT KORPUS

12041 Grün Silber

12042 Rot (ähnl. RAL 3002) Silber

12044 Blau Silber

12047 Ultramarinblau (RAL 5002) Silber

12046 Silber Schwarz

Friedrich Küpper GmbH
Friedrich-Küpper-Weg
54570 Berlingen
Deutschland

Telefon +49 (0) 65 91 - 95 42 0
Telefax +49 (0) 65 91 - 95 42 17
E-Mail info@friedrich-kuepper-gmbh.de
Internet www.friedrich-kuepper-gmbh.de

EINZELTEILE / PIECES

A

1x

772 mm x 475 mm



C

1x

1057 mm x 473 mm



B

1x

772 mm x 475 mm



D

1x

1057 mm x 473 mm



F

1x

645 mm x 450 mm



E

1x

985 mm x 480 mm



K

1x

403 mm x 468 mm



Y

1x

1200 mm x 600 mm



L

1x

400 mm x 25 mm



J

5x

450 mm x 120 mm



X

5x

450 mm x 20 mm

CR DR CL DL



H

5x

450 mm x 445 mm









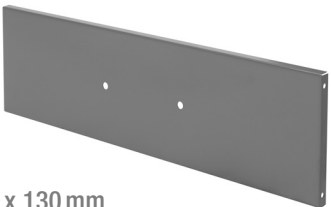





I

5x







470 mm x 130 mm

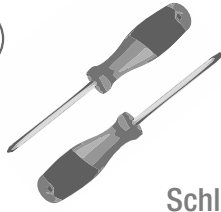

BEUTELINHALT / BAG CONTENT

 6x 5,5x19 mm	 10x KU 4x16 mm	 18x M5x10 mm	 18x ø5,3 mm	 18x M5	 40x M4 x 10 mm
 40x M4	 1x M6x16 mm	 1x ø6,4 mm	 1x M6	 1x 6x12 mm	 1x
 1x	 1x	 4x	 4x	 4x M8	 5x

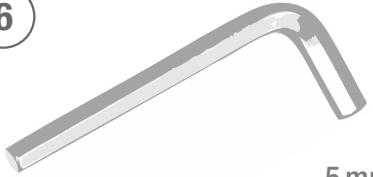
BENÖTIGTES WERKZEUG / NEEDED TOOLS



<p>①</p>  <p>PH 1 x 100 PH 2 x 100 Schlitz 6,5 x 150</p>	<p>②</p>  <p>SW 7 SW 8 SW 10</p>	<p>③</p>  <p>4 mm</p>
<p>④</p> 	<p>⑤</p> 	<p>⑥</p>  <p>5 mm</p>
<p>⑦</p> 	<p>⑧</p> 	

1.



2. WICHTIG / IMPORTANT



3.  2x M5  2x M5 x 10  2x 5,3 MM

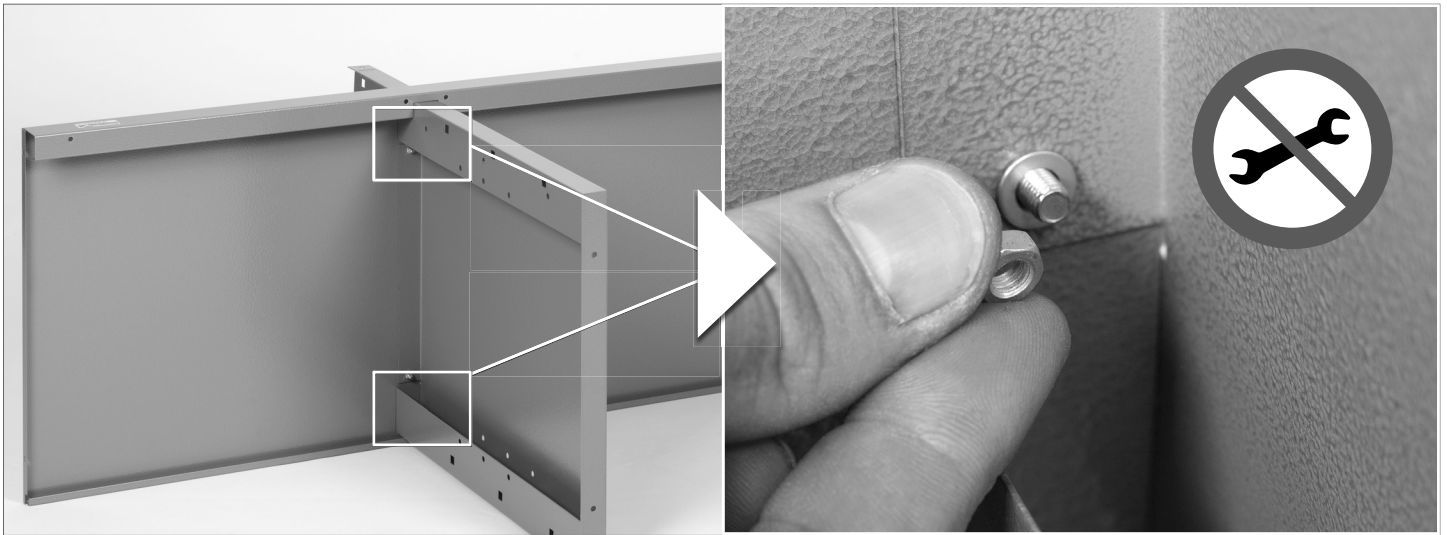

4.

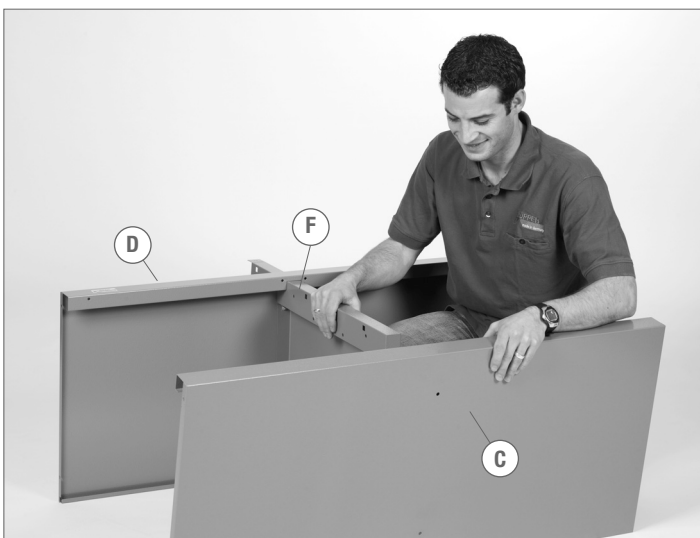

5.  2x M5  2x M5 x 10  2x 5,3 MM  2 SW 8  1 PH 2 X 100

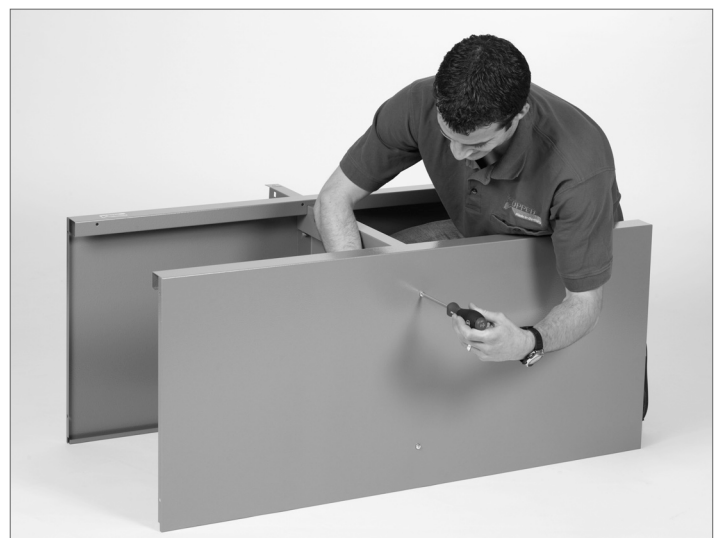

6.

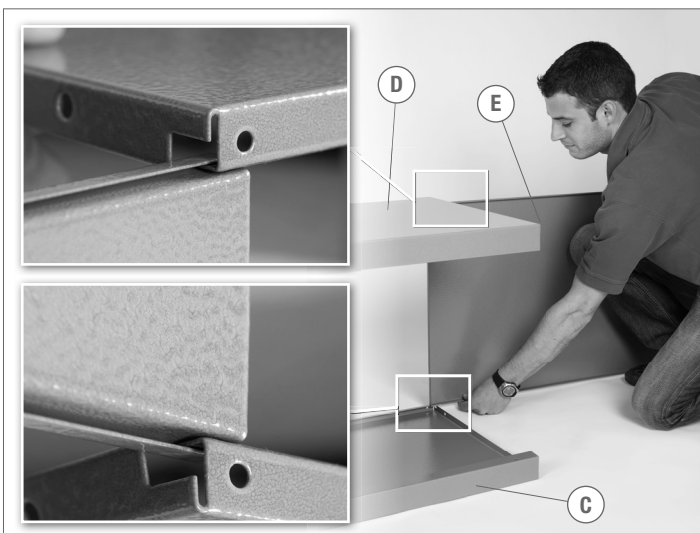

7.

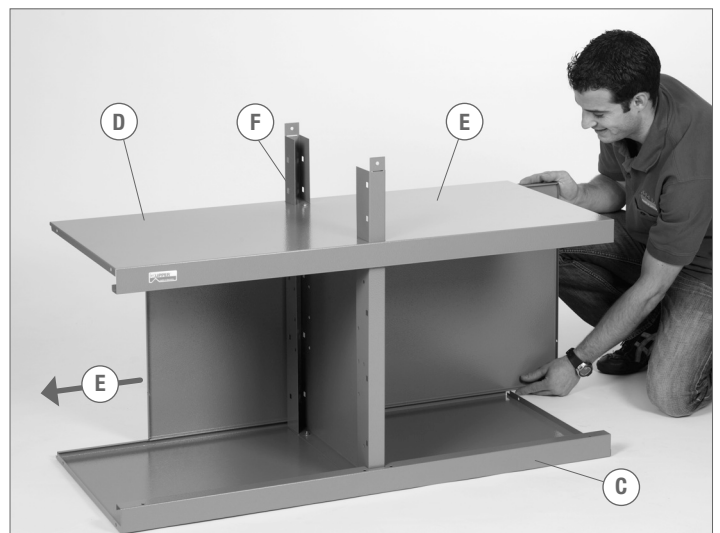

ZU SCHRITT 4. / IN ADDITION TO STEP 4.

②  SW 8 ①  PH 2x100

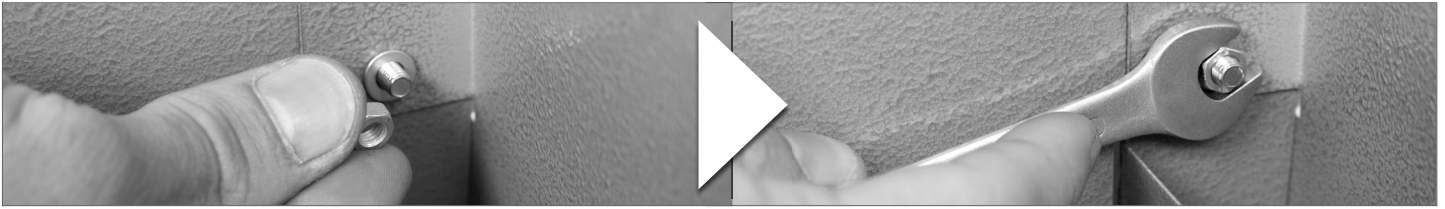

8. WICHTIG / IMPORTANT



9. WICHTIG / IMPORTANT

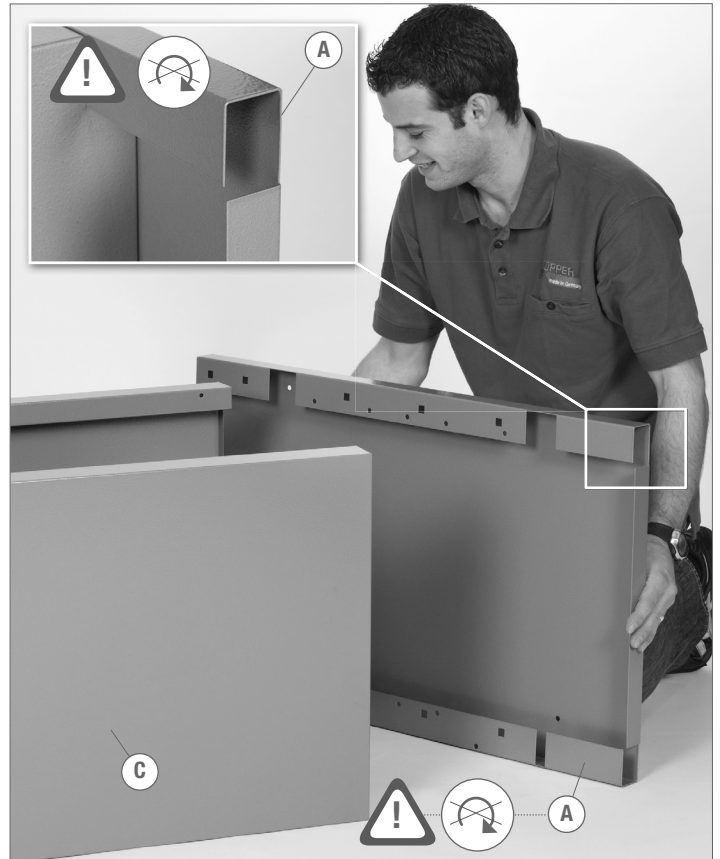

10.  6x M5  6x M5 x 10  6x 5,3 MM ②  SW 8 ①  PH 2x100

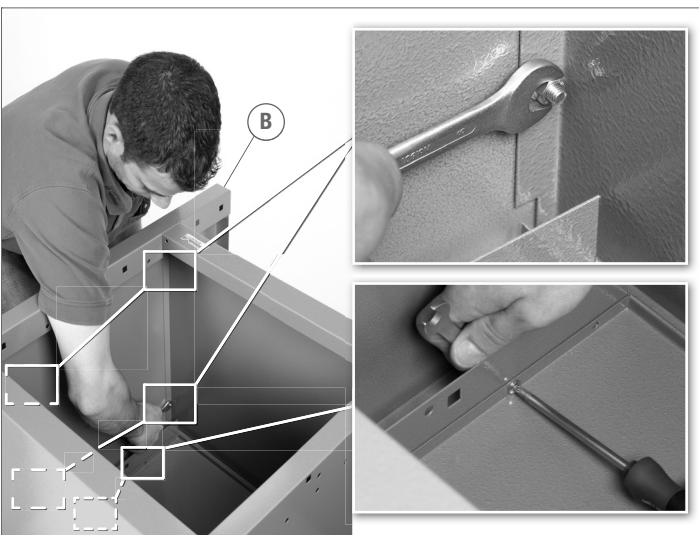

11.  6x M5  6x M5 x 10  6x 5,3 MM ②  SW 8 ①  PH 2x100

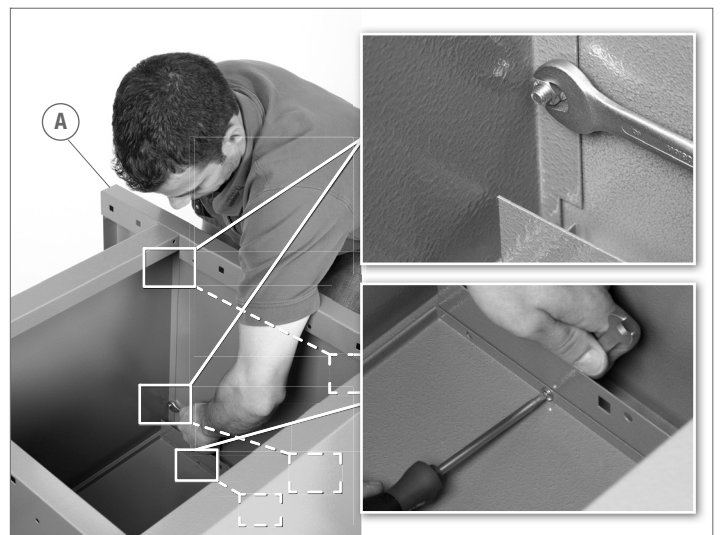

12. 4x M8 4x 4x 4x

5

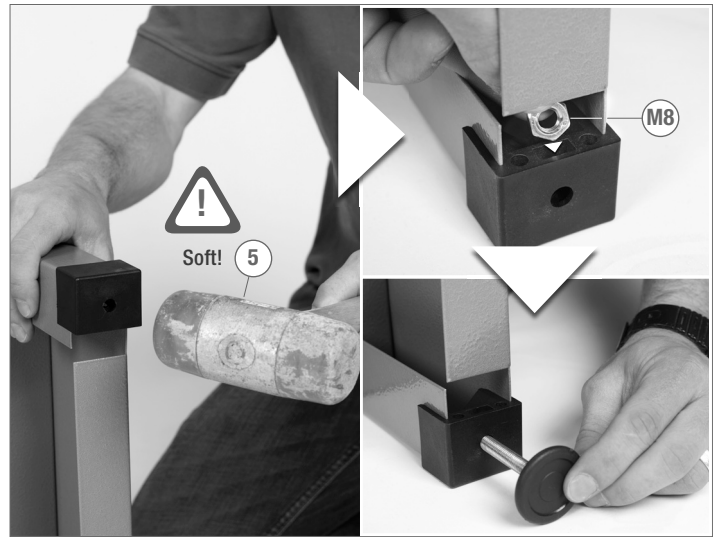

13. 2x M5 2x M5 x 10 2x 5,3 mm

2 SW8 1 PH 2 x 100

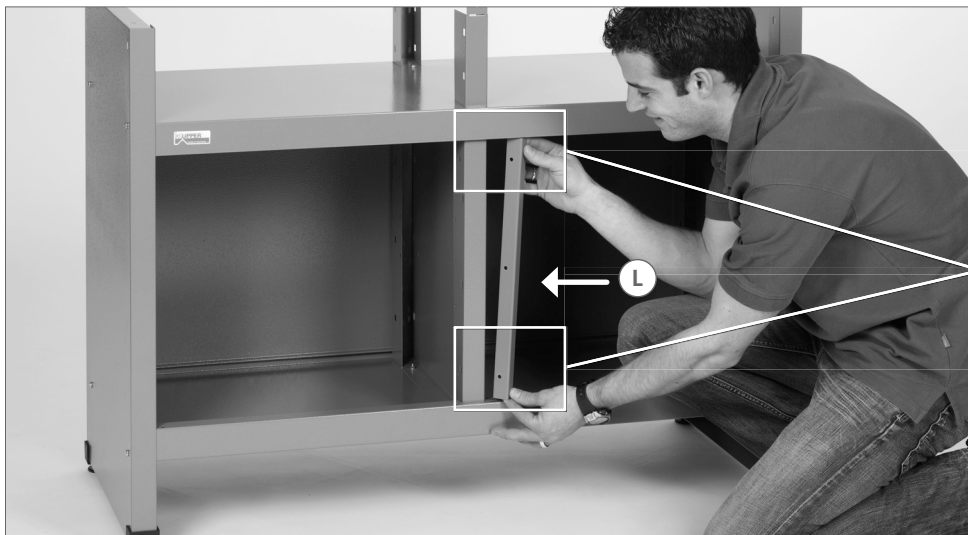

14.

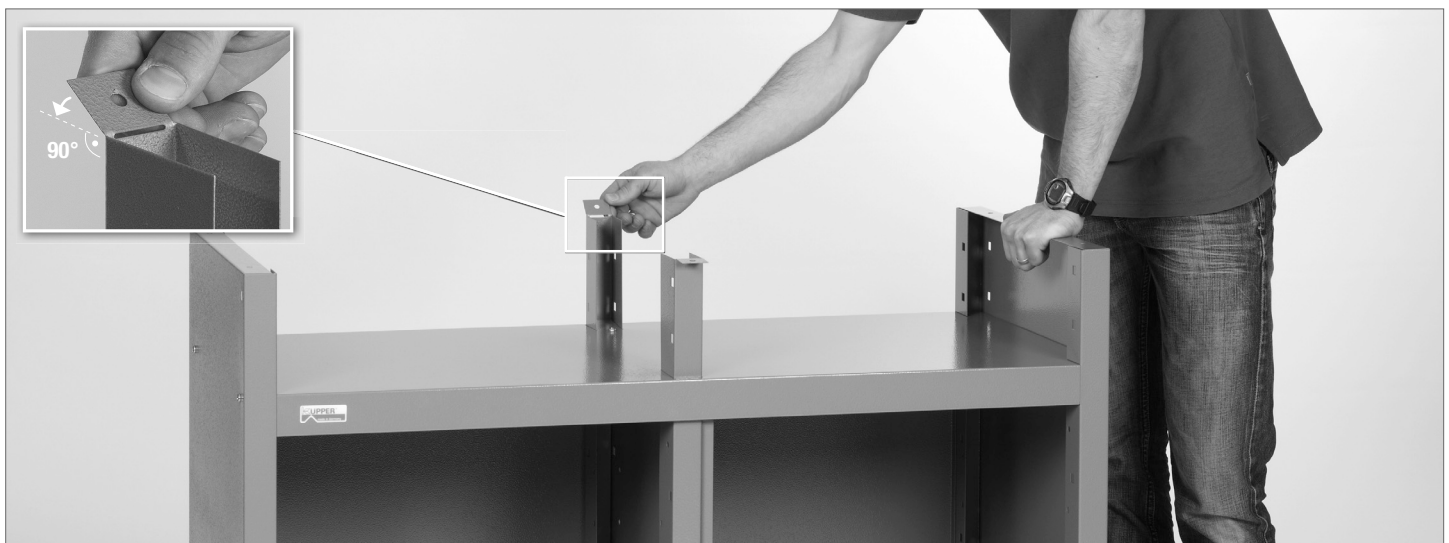

15.  1x  1x 6x12

 ① Schlitz 6,5 x 150

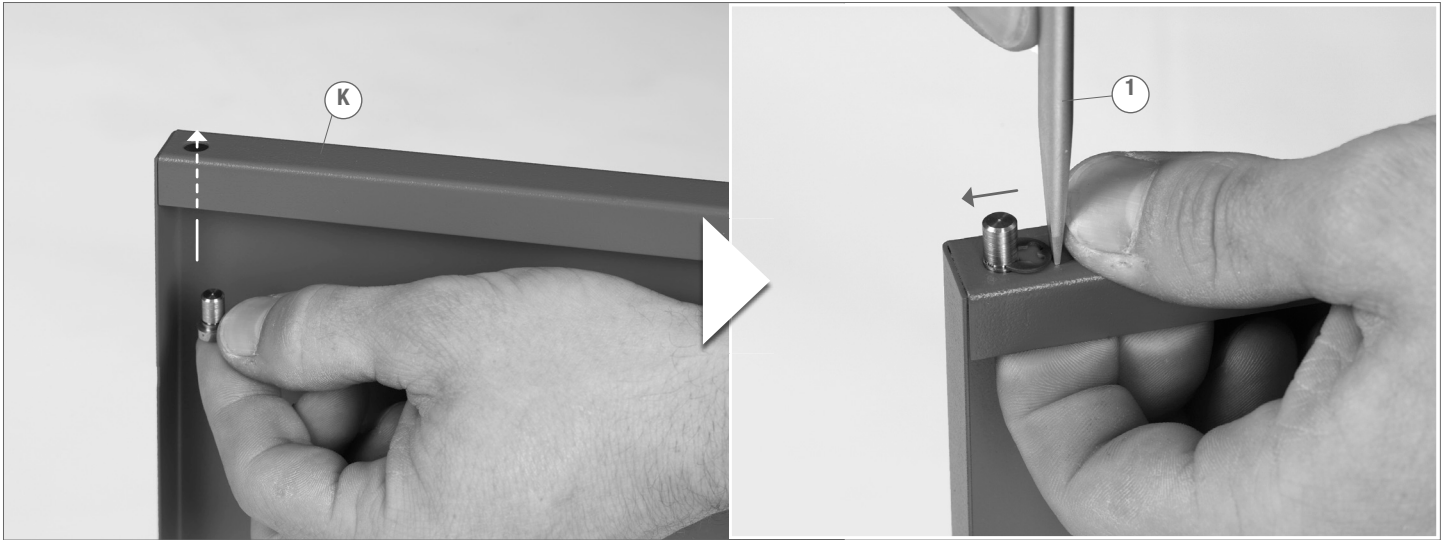

16.

17.  1x M6  1x M6x16  1x 6,4mm  ② SW 10  ⑥

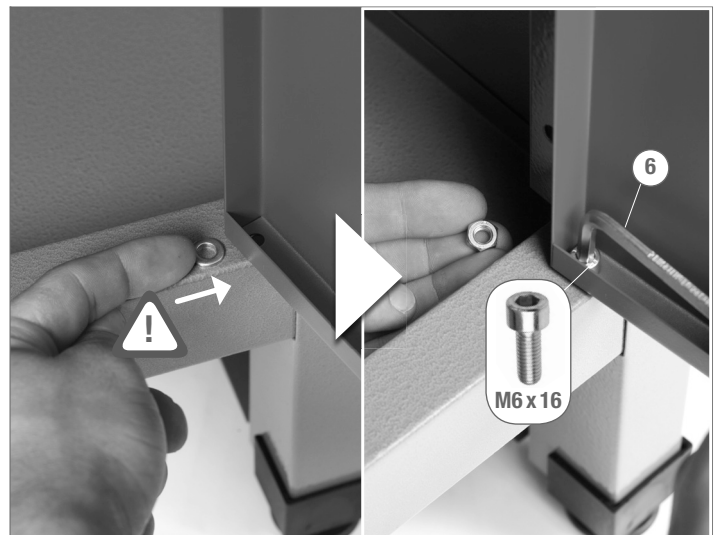

18.  1x  1x

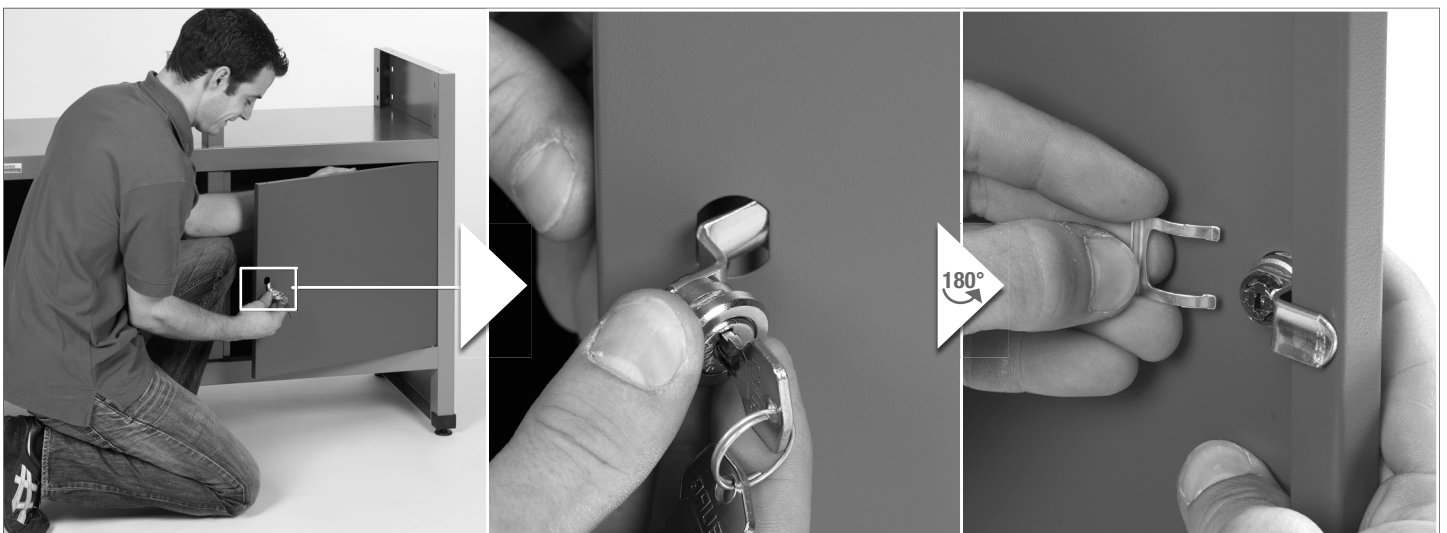

19.

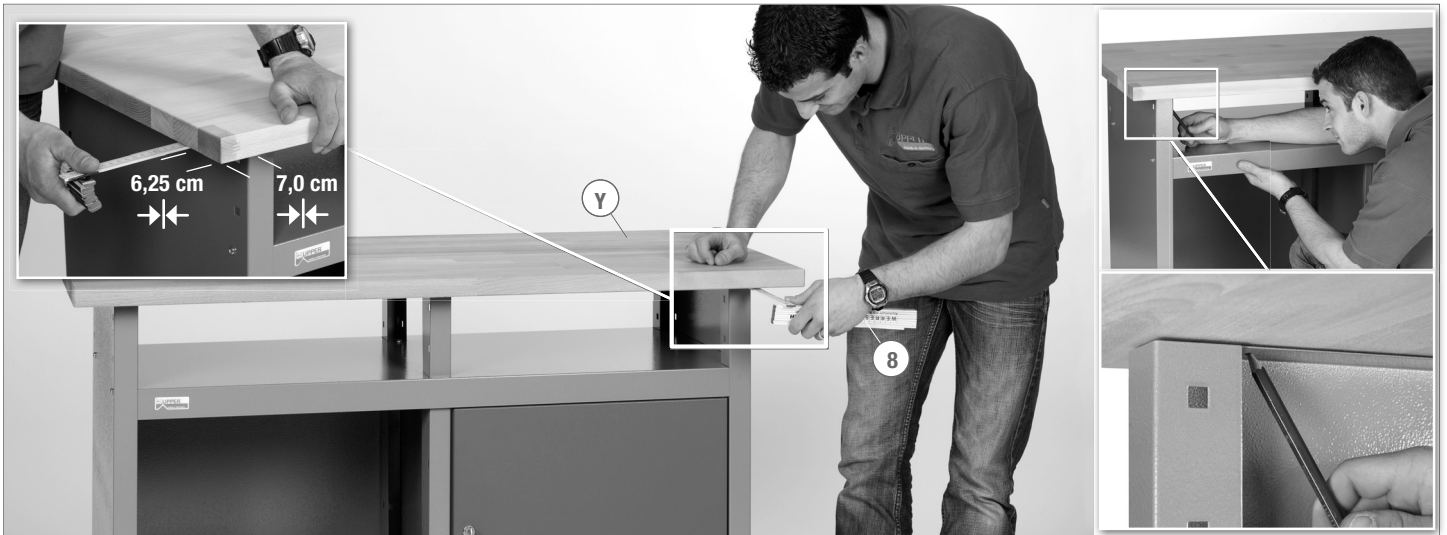

20.



21.

6x 5,5 x 19



22.

5x CR



23.

5x CL

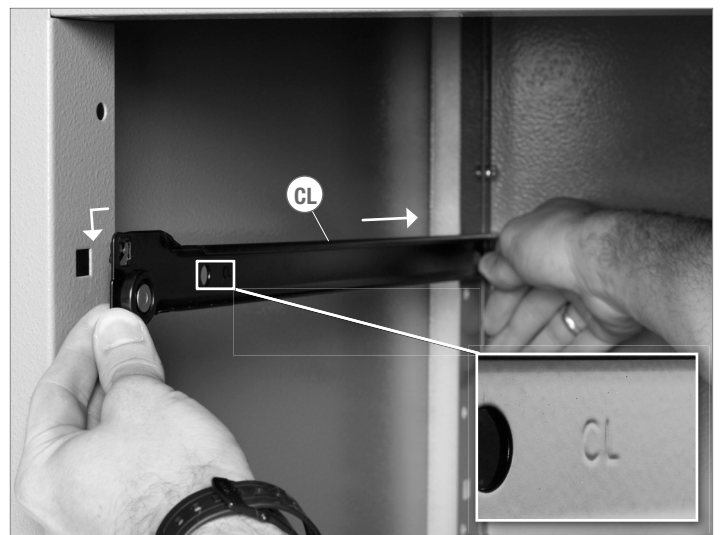

24. 10x M4 10x M4 x 10

② SW 7 ① PH 1 x 100

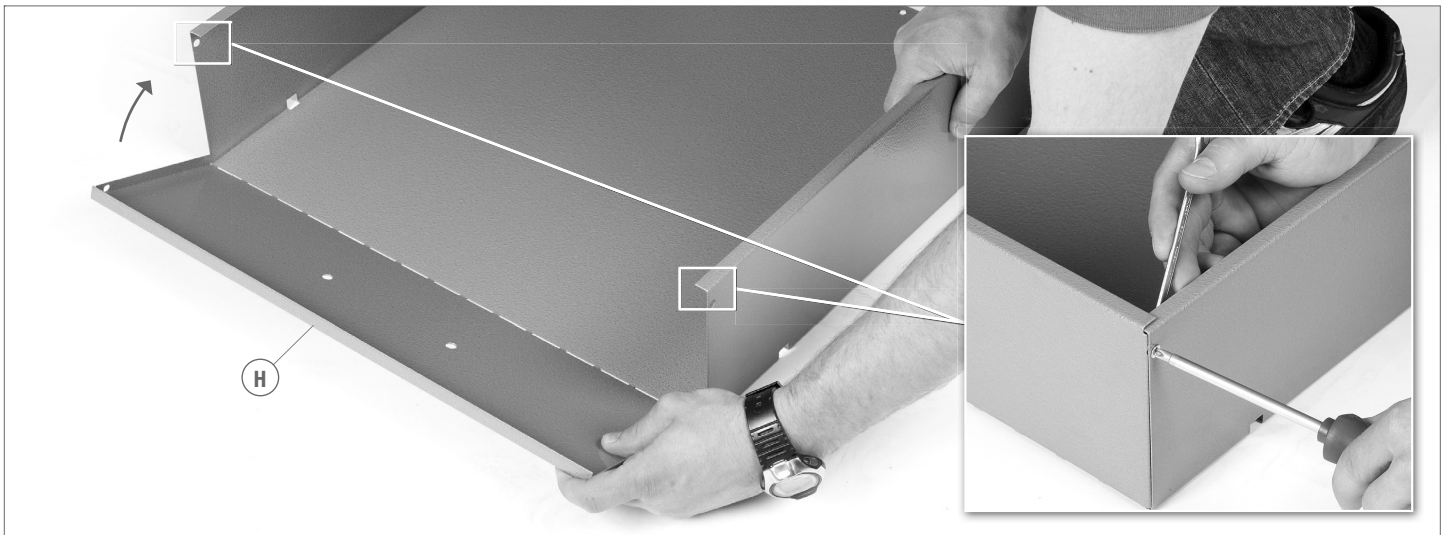

25. 30x M4 30x M4 x 10

② SW 7 ① PH 1 x 100

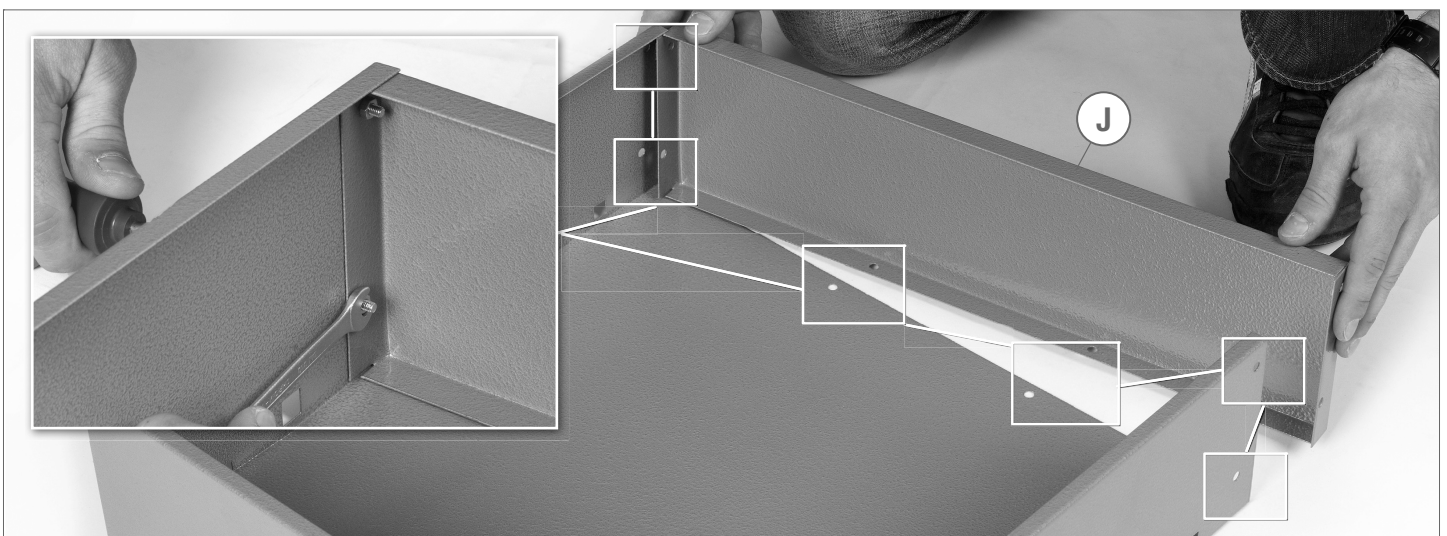

26.

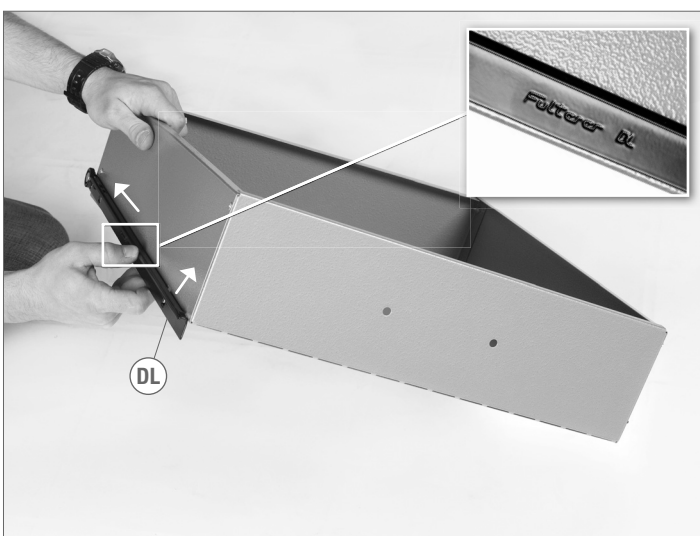

27.

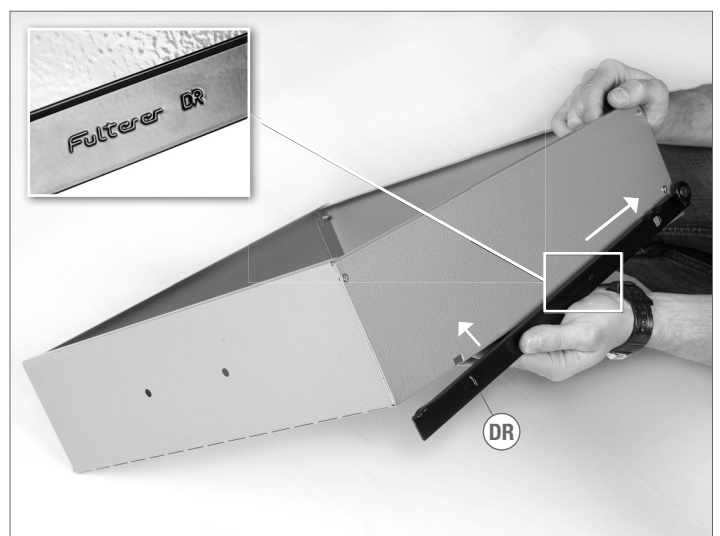

28.

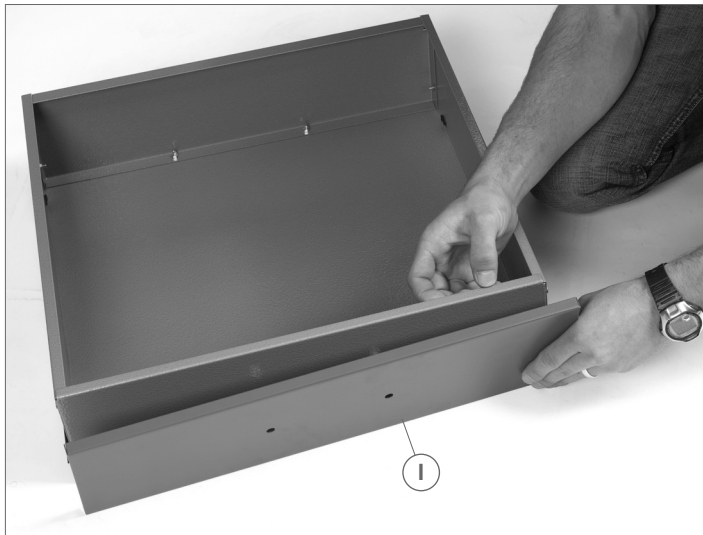

29.

10x KU 4 x 16

5x



1

PH 2x100



30.





Modell-Nr.

12040